



# **OWNER'S MANUAL**

## **GENERAL GASOLINE ENGINE**

M70R (170F-2R)

**CHONGQING LIFAN POWER CO.,LTD.**

## PREFACE

Thank you for choosing a general gasoline engine by our company.

Based on the latest engine technology at home and abroad, our Co. has individually developed general gasoline engines with 4-stroke single cylinder, OHV and forced-air cooling. The engines are characterized by advanced design, compact structure, reliable performance, convenient service low fuel consumption and easy speed adjustment. They are widely used as ideal power in many fields such as generating set, tour, open working, public place of entertainment, construction machine, agricultural machinery, etc. the vital part bodies including cylinder cover, crankcase, etc, are all cast formed with aluminum alloy. Laser-scanning technology, 3D shaping technology and CN program processing technology used in the mould production upgrade the engine surface and manufacturing accuracy obviously. Applying auto-press reducing system and centrifugal fly hammer regulating system assure that assemblies equipped with the engine function smoothly and reliably as well as the engine start easily. Besides, the introduction of the lubricant film-sensing protection system prevents accidental damage of the engine for poor lubrication.

The manual gives information with respect to operation and maintenance of the general gasoline engine, and be sure to read it carefully first before operating. All the materials and diagrams of this manual are in accordance with the newest products at the publishing time. Due to revision and other change, the information described in this manual may be a little different from the actual status. The copyright of this manual belongs to our Co., any group or individual is forbidden to reprint or copy any it. The manual is subject to change without notice.

Please pay special attention to statements preceded by the following words:

### **⚠ WARNING**

● A warning is used to alert the user to fact that hazardous operation and maintenance procedures may result in injury to or death of personnel if not strictly observed.

### **CAUTION**

● A caution is used to alert the user to fact that hazardous operation and maintenance procedures may result in injury to or death of personnel if not strictly observed.

### **NOTE**

● A note is used to give helpful information.

This manual book is the part of engine; it must be along with the engine.

# CONTENTS

Safety Precautions.....	6
Parts Description.....	7
Pre-Operate Inspection.....	8
I. Engine Oil.....	8
II. Oil in the reduction gearbox (only for equipped model).....	9
III. Air cleaner.....	10
IV. Fuel.....	12
Starting of the Engine.....	14
Operation.....	16
Stop.....	19
Exhaust Control System.....	20
Maintenance.....	22
I. Maintenance schedule.....	22
II. Maintenance method.....	23
1.Replacement of Engine Oil.....	23
2.Service of Air Cleaner.....	24
3.Washing of Deposit Cup.....	27
4.Spark Plug.....	28

5. Spark Eliminator (Option).....	30
6. Adjustment of Carburetor Idling.....	31
Transport and Storage.....	32
Troubleshooting.....	33
Specifications.....	43
Electric Diagram.....	46

## **SAFETY PRECAUTIONS**

### **△ WARNING**

**Before operating the engine, be sure to read and familiar with the manual carefully, otherwise injury to personnel or damage to equipment may occur.**

Please pay special attention to the following:

1. Running the engine in a well-ventilated place, keep it at least one meter away from building walls or other equipments; keep away from inflammables such as gasoline, matches and so on to avoid possibility of fire.
2. Keep the engine out of reach of children and pets to avoid accidents.
3. Operator on the engine has been specially trained.
4. Refuel in a well-ventilated area with the engine stopped, and in places refueling or storing gasoline, no smoking and any flames or sparks.
5. Refuel the fuel tank not too full so as to avoid fuel's spilling out. If there is spilled fuel around, be sure to clean it thoroughly before starting.
6. Locate the engine on a level-working platform to avoid fuel's spilling out.
7. Make sure the fuel filler cap is tightened securely.

The exhaust muffler is very hot during running the engine even after the engine stops. Never touch it, or you may get burns. Transport or store the engine with it cooling down entirely.

## PARTS DESCRIPTION

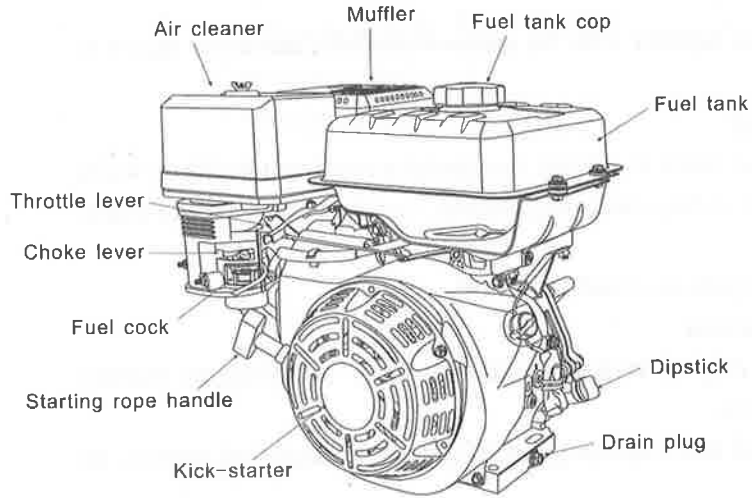

(Pic.1)

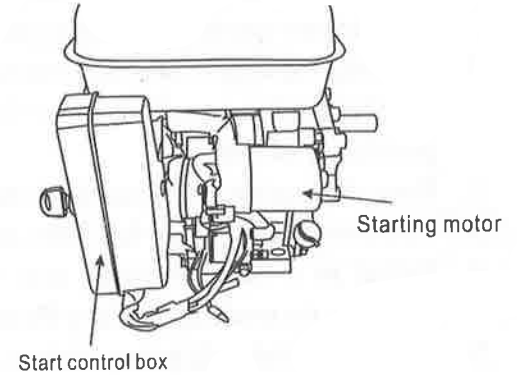

(Pic.2)

# PRE-OPERATE INSPECTION

## I .ENGINE OIL

### CAUTION

- Engine oil is a key factor in deciding the engine's performance. Do not apply engine oil with additives or 2-stroke gasoline oil, as they haven't enough lubrication, which may shorten the engine's service life.
- Check the engine with it stopped on a level ground.

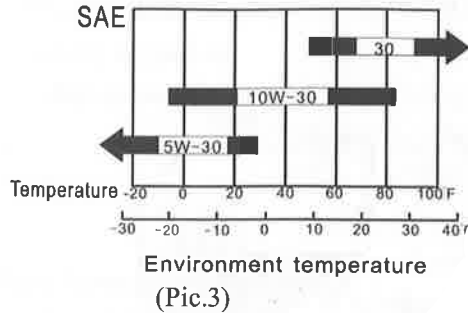

Engine oil recommended: SAE10W-30. As viscosity varies with regions and temperatures, so the Lubricant has to be selected in accordance with our recommendation. (Pic.3)

### Inspect step:

1. Remove the dipstick and clean it. (Pic. 4)
2. Reinsert the dipstick into the oil filler without screwing in, and check oil level.

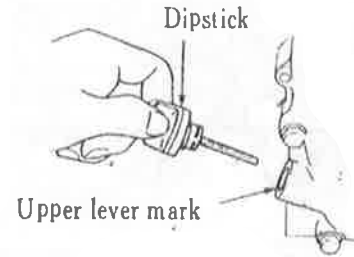

(Pic.4)



3. If the oil level is too low, add recommended engine oil to the filler neck.
4. Reinstall the dipstick.

### CAUTION

**Run with insufficient engine oil may damage the engine severely.**

### II. OIL IN THE REDUCTION GEAR BOX (only for the model equipped with it)

1/2 Reduction gearbox with an auto-centrifugal clutch.

1. Remove the dipstick and clean it. (Pic. 5. Pic.6)
2. Reinsert the dipstick without screwing it in, and then take out it and check oil level.
3. If the oil level is too low, and recommended engine oil until it arrives the upper level mark.  
Brand of the oil is the same as that of engine oil.

Oil capacity: 0.50 liters

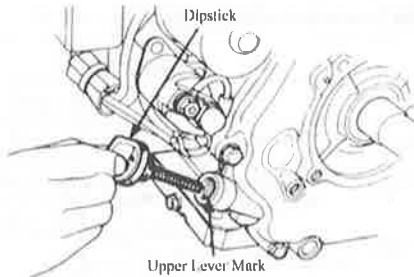

(Pic.5)

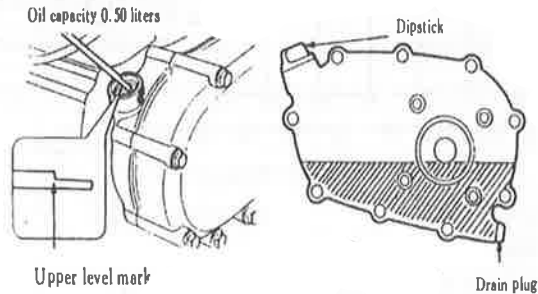

(Pic.6)

### III. AIR CLENERER

#### Double-core type (Pic. 7)

Dismantle the air cleaner housing and check its filter element, make sure it is clean and intact, otherwise clean or replace it.

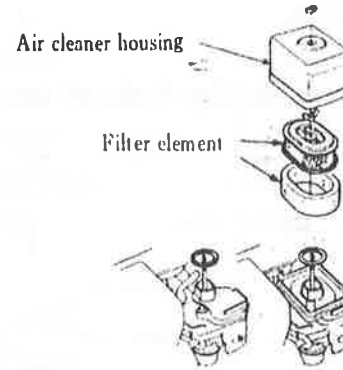

Pic.7

#### Semi -dry type (Fig. 8)

- a) Remove the air cleaner housing and check the filter element for dirt and impurity. Clean or replacement should be done if necessary.
- b) Check the air cleaner for dirt, and remove it if any.

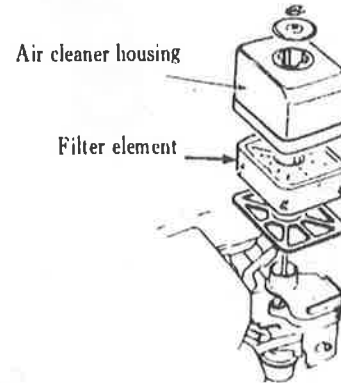

Pic.8

### Oil – bath type (Fig.9)

- a) Dismantle the air cleaner housing and check its core, make sure it is clean and intact, otherwise clean or replace it.
- b) Check oil level and oil quality. If the oil level is too low, add recommended engine oil to oil level mark.

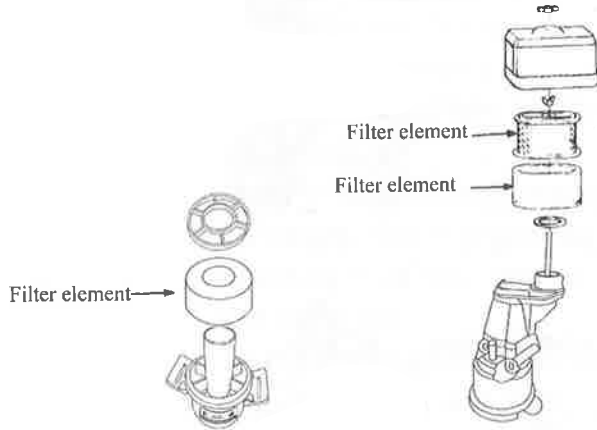

Pic.9

## IV. FUEL

1. Gasoline is extremely flammable and may explosive under certain conditions.
2. Refueling in a well – ventilation area with the engine stopped. Do not smoke and allow flames or sparks  
In the area where gasoline is stored or where the fuel tank is refueled.
3. Do not overfill the tank (there should be no fuel in the filler neck). After refueling, make sure the fuel tank cap is set back securely.
4. Be careful not to spill fuel when refueling. Spilled fuel or fuel vapor may ignite. If any fuel is spilled, make sure the area is dry enough before starting the engine.
5. Avoid repeated or prolonged contact with skin or breathing of fuel vapor. Keep out of reach of children.

Fuel tank capacity: 3.6liters

The engine must apply unleaded gasoline with an octane number over 86. Using unleaded gasoline will decrease the possibility of producing carbon deposit and prolong the engine's service life.

Never apply used or polluted gasoline or a mixture of gasoline and engine oil. Make sure the fuel is free of dirt and water.

## CAUTION

- Handle fuel with care because it can damage plastic and painted surfaces. It is not in our guarantee range of damage by fuel spilling.
- It is normal when you hear occasionally light spark knock or pinking with the engine running under heavy load.
  - Should spark knock or pinking be heard at a speed under normal load, change brand of gasoline; If such phenomenon still happens, consult your dealer for help, otherwise, the engine may be damaged.

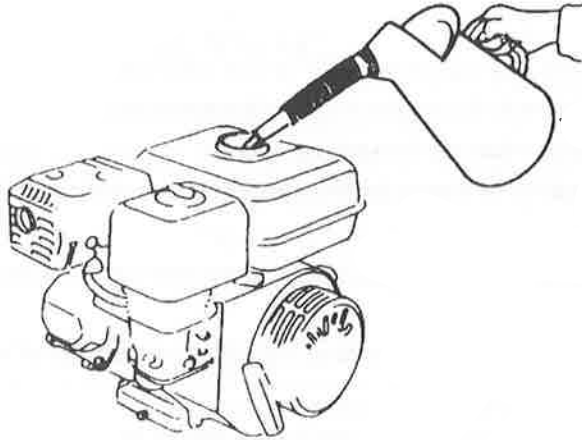

Pic.10

## CAUTION

The engine would be damage when it is running with constantly knock or pinking noise. It is not in our warranty range that its damage by misusage the engine

## STARTING OF THE ENGINE

1. Push the fuel switch to "ON". (Pic.11)

Fuel guard

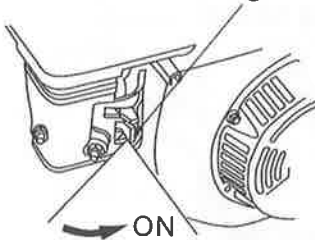

(Pic.11)

### NOTE

If the engine is hot, closing the choke is unnecessary.

3. Move left the throttle lever a little. (Pic.13)

2. Push the choke lever to "OFF". (Pic.12)

Choke lever

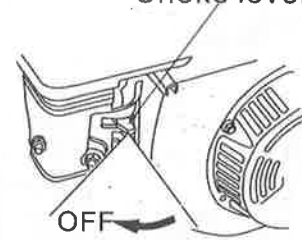

(Pic.12)

Throttle lever

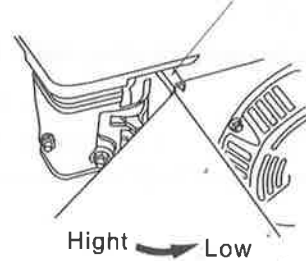

(Pic.13)

#### 4. Start the engine

##### a). Rope handle Starter.

Push the engine switch to “ON”. (Pic. 14) Pull slightly the starting rope handle up until feeling anti-action, and then make a rapid pull. (Pic. 15)

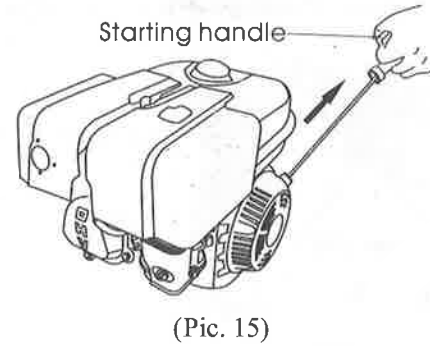
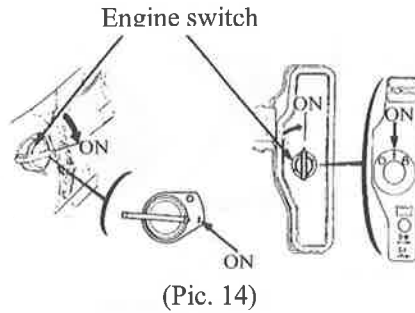

#### CAUTION

Releasing the handle suddenly may make it hitting the engine. Release the handle slowly conforming to its recoiling force.

##### 2) Electric starter

Push the engine switch to “START” and remain there until the engine Start. (Pic. 16)

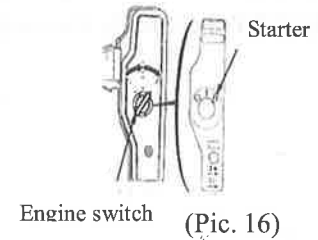

## CAUTION

Use the engine switch not more than 5 second each time to avoid damage of the engine. Try once more 10 second later after last attempt failures.

Once the engine starts, reset the engine switch to “ON”.

## OPERATION

1. Preheat the engine and push back the choke lever to “ON”.(Pic.17)

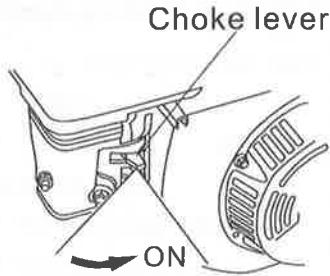

(Pic .17)

2. Set the throttle lever in proper position to ensure the engine runs at required velocity.(Pic.18)

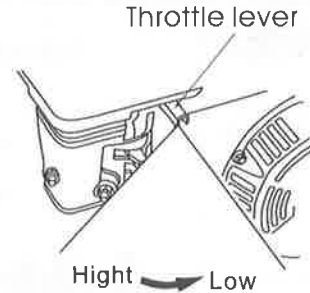

(Pic .18)



### ★ Engine Oil Alarm

The engine oil alarm is designed to alarm the user the fact that the engine oil in the crankcase is insufficient. Run with insufficient engine oil may damage the engine. Once oil level in the crankcase is too low, the engine oil alarm will stall the engine automatically to make it free of damage while the engine switch is still at "ON".

#### CAUTION

If the engine still fails to work, check the engine oil level first before go to other check items.

### Breaker (Electric start)

Breaker is used to protect the battery charging circuit. It will be disconnection when short circuit or battery polarity connects in wrong direction. (Pic .19)

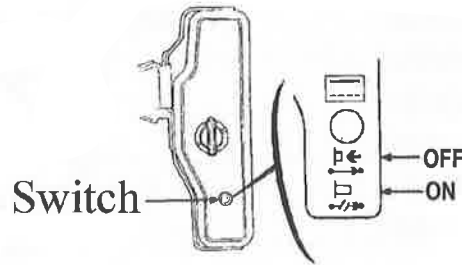

(Pic .19)

The green indicator would be light once the circuit off. If this happens, please find out the reason and solve it then press the button to recover the breaker.

★ **Operating on Highlands**

On highlands, the standard mixture ratio is relatively too big so the engine performance may be impaired while the fuel consumption may increase. This problem can be solved as follows: replace the main jet of carburetor with a smaller one, then, adjust the idly screw. If always using on highlands with a height above sea level of 1830 meters, ask your dealer for doing the job.

The engine power will decrease by about 3.5% with every 305 meters up in height; even the proper main jet is used. The output would be much lower if not adjust the jet.

**CAUTION**

The engine equipped with the main jet applicable to highlands may be damaged seriously in area below specified altitude, because its mixture ratio is too thin, output drops and the engine overheats for operation in low altitude area. In the case, ask your dealer to recover the engine to its normal technical status.

## STOP

In an emergency, push the engine switch to “OFF” to stall the engine. Stop it in normal in the following sequence:

1. Push right the throttle valve lever to the bottom (Pic. 20).

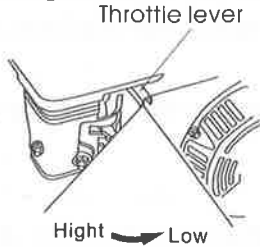

(Pic. 20)

2. Push the engine switch to “OFF” (Pic. 21)

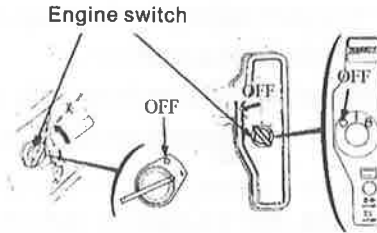

(Pic. 21)

3. Set the fuel switch to “OFF” (Pic. 22)

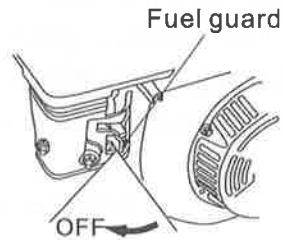

(Pic.22)

## EXHAUST CONTROL SYSTEM

With the engine running, carbon monoxide, oxide of nitrogen and hydrocarbon will produce, and in certain conditions, oxide of nitrogen and hydrocarbon will react chemically each other to make smoke while carbon monoxide is toxic, so exhaust control of them is very important. The company decreases the exhaust emissions by introducing poor-fuel carburetors and other devices into the engine to solve the problem.

To keep the exhaust of your engine within the standard exhaust emission values, pay attention to the following:

### I. MAINTENANCE

Maintain the engine periodically in accordance with the Maintenance Schedule in the manual. The maintenance schedule is made out on the base of normal use in normal conditions, if using under heavy load, dusty or wet circumstances or in high temperature, more frequents maintenance will be necessary.

### II. REPLACEMENT OF PARTS

We recommend that you should choose such parts, which are manufactured by our Co. or equivalent to these in quality as replacement ones. Replacement without so high quality may impair the exhaust control system in effectiveness.

### III. MODIFYING

Modifying the exhaust control system may make actual exhaust emissions exceeding statutory limit values. Illegal modification is as follows:

1. Dismantle or modify any part of air inlet or outlet system.
2. Modify or take off speed-adjusting connection device or speed adjustment device to result in the engine's running

or outside the set parameters.

#### IV.PROBLEMS AFFECTING EXHAUST EMISSIONS

1. Difficult starting or difficult stopping.
- 2.Unstable idling.
- 3.Give off black smoke or consume too much fuel.
- 4.Poor ignition sparks or sparks returned.
- 5.Ignition is too advanced.

Once you find any of above problems, contact your dealer for help.

# MAINTENANCE

## I. MAINTENANCE SCHEDULE

To keep the engine in a sound condition, the user should maintain it according to the table below:

Frequency	Items	Each time	Initial 1 month or 20 Hrs	Initial 3 month or 50 Hrs	Every 6 month or 100 Hrs	Every 1 years or 300 Hrs	
Engine oil	Check oil level	△					
	Replace		△		△		
Reduction Gear oil	Oil level check	△					
	Replace		△		△		
Air cleaner	Check	△					
	Clean			△	△①*		
	Replace-clean					△**	
Deposit cup	Clean				△		
Spark plug	Clean, adjust				△		
	Replace					△	
Spark eliminator	Clean				△		
Idling	Check-adjust					△②	
Valve clearance	Check-adjust					△②	
Fuel tank & Fuel filter	Clean					△②	
Fuel supply line	Check	Every two years (do a replacement if necessary)					

## NOTES

★: Only for inside-ventilating double-core carburetors.

★★: Only for paper core air cleaners.

1) More often than that in the schedule if in dusty circumstances.

2) The items should be done by your dealer you are specially trained and is well equipped with tools.

### II. MAINTENANCE METHOD

#### 1. Replacement of Engine Oil

A still hot engine is helpful to drain out the engine oil in the crankcase rapidly and entirely. (Pic. 23)

1) Turn off the oil filler cap and drain plug to drain engine oil thoroughly. Reinstall the drain plug and screw in securely.

2) Fill the specified engine oil to the upper lever mark..

3) Reinstall the oil filler cap.

Engine oil capacity of the crankcase is 0.6 liters.

Engine oil capacity of the 1/2 reduction gearbox is 0.5 liters

Engine oil capacity of the 1/6 reduction gearbox is 0.15 liter

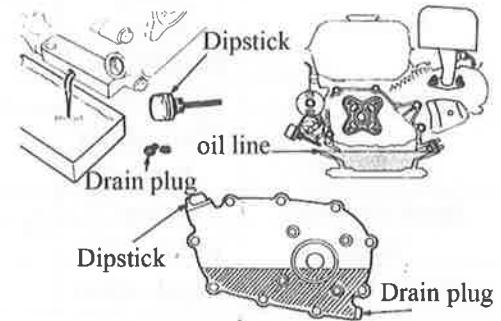

(Pic. 23)

## NOTE

Do not dump oil containers or discarded engine oil into rubbish boxes or onto the ground. For the sake of environmental protection, we suggest you take in discarded engine oil with a closed container and bring to local recycling station.

## 2. Service of Air Cleaner

A dirty air cleaner may block enough air's flowing into the carburetor. To keep the carburetor in good working conditions, please service the air cleaner periodically. If operating the engine in extremely dusty area, the job should be done more often.

### ⚠ WARNING

**Never clean the air cleaner core in gasoline or low flash-point detergents, or explosion may happen.**

### CAUTION

**Never run the engine without an air cleaner, or air with dirt and dust may enter the engine so speed the engine's wear.**

### ★ Double-core type (Pic. 24)

Unscrew the wing nut, dismantle the air cleaner housing. Check the two cores for damage. If any, replace with new one.

- a) Foam filter element: clean with home detergents

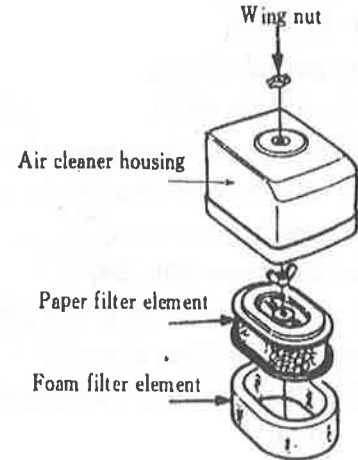

Pic.24



and warm water (or non-flammable or high flash – point cleaning solvents) and dry up, then soak in clean engine oil until saturated. Squeeze out excess oil, otherwise, the engine will discharge smoke in starting stage.

b) Paper filter element: knock the core against a solid plane to get rid of accumulated dust or blow out dust from inside to outside with high – pressure air flow (not more than 30psi). Never clean with a brush, as brushing may force the dust into the core fiber. If the core is extremely filthy, replace it with a new one.

★ **Semi-dry type (Pic. 25)**

- a) Unscrew the wing nut, remove the air cleaner housing, then take out the filter element.
- b) Clean the filter element with non-flammable or high flash-point cleansing solvents, and dry it up.
- c) Soak the core in clean engine oil until saturated. Squeeze excess oil, otherwise the engine will discharge smoke in starting stage.
- d) Install the parts to original position.

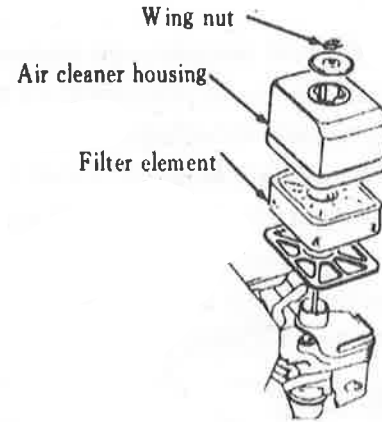

Pic.25

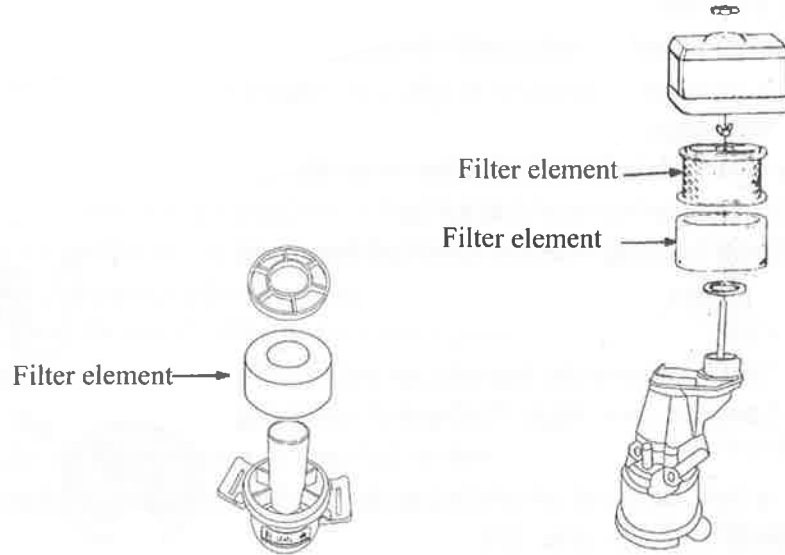

Pic.26

★ Oil bath type (Fig. 26)

- a) Remove the wing nut and air cleaner housing, and take out the filter element. Check if both the cores are damaged. If any, replace it with new one.
- b) Clean the bores with home detergents (or high flash-point cleansing solvents) and warm

water, and dry them up.

- c) Soak them in clean engine oil until saturated. Squeeze excess oil, or the engine will discharge smoke in starting stage.
- d) Empty the air cleaner housing of oil, clear away the dust inside with non-flammable or high flash-point cleansing solvents, and dry it up.
- e) Fill the air cleaner housing with the specified engine oil to the standard oil level mark.

### 3. Washing of Deposit Cup.

Set the fuel switch at “OFF”, remove the deposit cup and O-ring. Wash them in non-flammable or high flash-point cleansing solvents, and then dry them up, at last, carry out reinstallation. Set the fuel switch to “ON” and check for leaks. (Pic. 27)

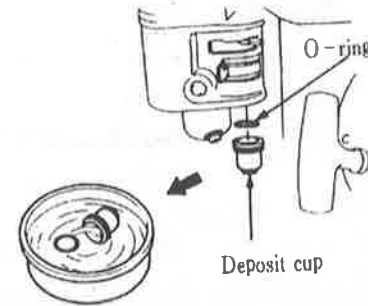

(Pic. 27)

### **⚠ WARNING**

- Gasoline is extremely flammable and explosive in certain conditions. Keep cigarette, sparks and open flames away.
- After reinstalling the deposit cup, check it for leakage and make sure the area around the engine is

dry enough.

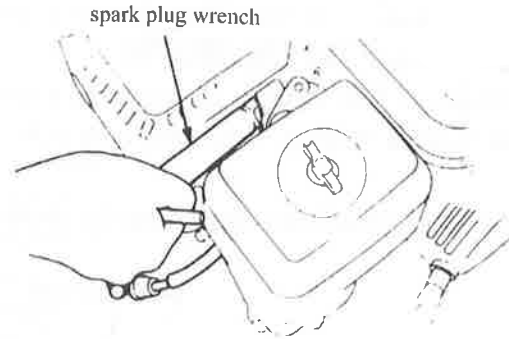

(Pic. 28)

#### 4. Spark Plug

Spark plug type: F6TC or BPR6ES (NGK)

Proper spark plug clearance and without deposit around the spark plug ensure the engine's normal running.

1) Remove the spark plug by means of spark plug wrench. (Pic. 28)

**⚠ WARNING**

**Be careful not to touch the muffler during or just after running the engine.**

- 2) Clean the spark plug with a steel brush. If the insulator is damaged, replace the spark plug instead.
- 3) Measure the spark plug clearance with a feeler. The clearance should be 0.7 ~ 0.8mm, If adjustment is necessary, bend the side electrode carefully. (Pic. 29)
- 4) Check if the spark plug gasket is in good conditions, or replace with a new one.
- 5) Screw on the spark plug to the bottom first by hand and then tighten it up by a spark plug wrench. (Pic. 30)

If a new spark plug is used, twist 1/2 more turns after impacting the gasket; if reinstall the original one, just twist 1/8 ~ 1/4 more turns.

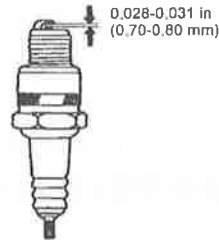

(Pic. 29)

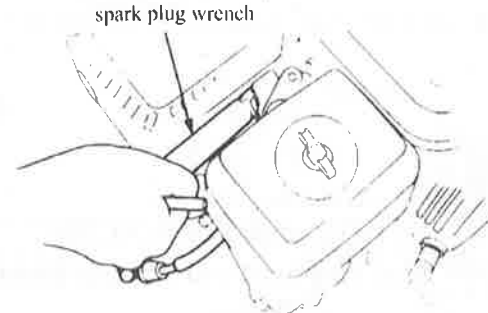

(Pic. 30)

### CAUTION

- The spark plug must be tightened securely, or it may become very hot to damage the engine.

● **Only use recommended spark plug or the equivalent. Incorrect heat range of the spark plug may damage the engine.**

### 5. Spark Eliminator (Option) (Pic. 31)

**The spark eliminator should be serviced at least once every 100 hour's operation so as to keep it in a sound condition.**

#### ⚠ WARNING

The muffler is very hot during running the engine and even a long Time after stopping. Never touch it, or you may get burns. Service After the engine cools down.

- a) Unscrew two nuts M4, and remove the exhaust elbow from the engine body.
- b) Turn off four screws M5 from the muffler guard and take out the latter.
- c) Turn off screw M4 from the spark eliminator and separate it from the muffler.
- d) Clear away carbon deposit from the spark eliminator mesh with a brush.

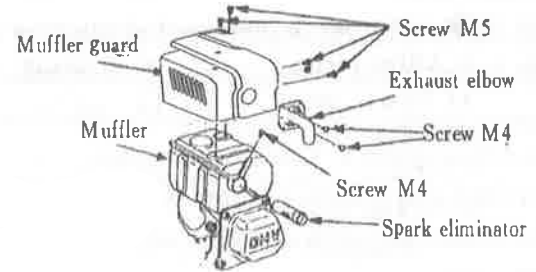

(Pic. 31)

e) Reinstall the spark eliminator in reverse order of removal. (Pic. 32)

### CAUTION

- Be careful not to damage the mesh of the spark eliminator.
- Never use a damaged spark eliminator.

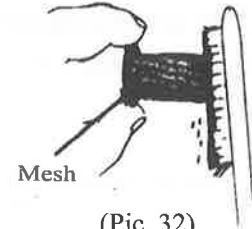

(Pic. 32)

### 6.Adjustment of Carburetor Idling

- Start and preheat the engine until arriving at its normal working temperature.
- Obtain standard idling by adjusting the throttle fixing screw under the engine runs at a low speed.  
(Pic. 33)

Standard idling:  $1500 \pm 100$ rpm

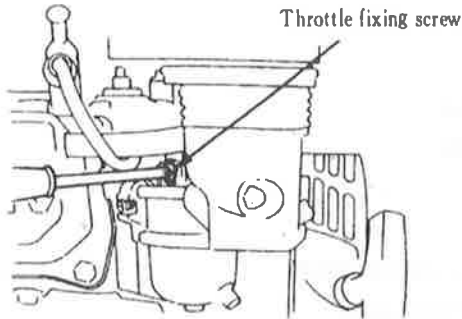

(Pic. 33)

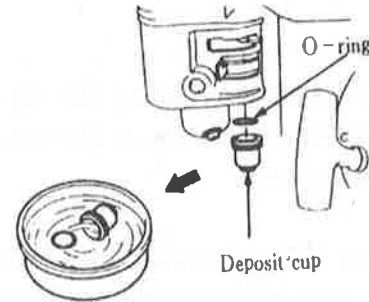

(Pic. 34)

## **TRANSPORT, STORAGE AND REMOVAL FROM STORAGE**

### **I. TRANSPORT**

Transport with the fuel switch turned off. Transport or store the engine it is cool so as to avoid getting burns or fire. If the engine is not kept in use for a long time, be sure to store it properly.

- 1) Make sure the storage area is dry and free of dust.
- 2) Make sure to put the oil (which in the gasoline tank and carburetor) into another proper container.

### **CURTION**

Fuel is extremely flammable and explosive under certain conditions. Keep cigarette, open flames and sparks away from operating site.

- 1) Replace the engine oil.
- 2) Disconnect the spark plug. Fill a spoon of fresh engine oil from the spark plug mount hole into the cylinder. Rotate the engine to distribute engine oil evenly, followed by fitting the spark plug to original position.
- 3) Pull the starting rope slowly until feel a slight anti-action, and then keep pulling so as to align the arrow of the starting sleeve with the hole of the starter. At this time, both the inlet and outlet valves are closed so to help prevent the engine inside from rusting.
- 4) Electric starter: disconnect the battery and store in dry and cool area. Charge once every month.
- 5) Cover the engine so keep dust away.



## TROUBLESHOOTING

### I . STARTING ENGINE DIFFICULTLY

TROUBLE	CAUSE	REMEDY
1. Something wrong with the fuel system	There is no enough fuel in fuel tank or fuel cock is closed	Fill fuel, open fuel cock
2. Fuel supply is blocked or on fuel. ▲ Normal cylinder compression ▲ Normal spark	Air vent in the filler cap is clogged.	Dredge air vent
	Fuel cock is clogged.	Clean first and then dredge
	Improper or clogged main jet	Readjust or clean, blow to get through
	Needle valve is closed improperly or start hole is clogged	Dismantle needle valve and repair, clean, blow to get through
	Floater is damaged or sticking	Repair floater
1. Something wrong with the fuel system ▲ Normal cylinder compression ▲ Normal spared ▲ Fuel flows easily and smoothly	Fuel is filthy or deteriorated	Replace
	There is filthy or deteriorated	Replace
	Too much fuel in engine cylinder	Drain extra fuel, dry up spark plug electrodes
	Wrong fuel brand	Select proper fuel brand corresponding with Requirements

TROUBLE	CAUSE	REMEDY
1. Spark plug is in bad condition ▲ Normal cylinder compression ▲ Normal fuel supply ▲ Normal high-pressure coil spark	Too much carbon fouling and dirt around electrodes	Clear away
	Electrodes are burn damaged seriously or insulators damaged	Replace spark plug
	Improper electrodes gap	Adjust to proper value
1. No high-pressure coil spark ▲ Normal cylinder compression ▲ Normal fuel supply ▲ Normal spark plug	High-pressure coil is damaged	Replace
	Ignition coil damaged	Replace

⚠ WARNING

- When testing the spark plug, never hold the high- voltage wire of the spark plug with wet hand.
- Make sure there is no spilled fuel outside the engine and that the spark plug isn't dipped with fuel.
- To prevent fire, keep sparks for away from the spark plug mount hole.

Once you find any of above problems, contact the authorization entitle to the dealer of the privilege helps for you.

<b>TROUBLE</b>	<b>CAUSE</b>	<b>REMEDY</b>
1. Poor cylinder compression ▲ Normal fuel supply system ▲ Normal ignition system	Piston ring is so worn to over its wear limit	Replace a set of piston rings
	Piston ring is sticking	Clear up carbon fouling
	Piston ring is broken	Replace
	Spark plug is not installed tighten or without a gasket	Tighten with a gasket in
	Air leakage between cylinder block and cylinder	Check cylinder gasket and the flatness of the surface by which cylinder block on-tacting with cylinder head; tighten cylinder bolts in the order to stipulated torque
	Air leakage in valve	Check valve clearance and tightness, repair if necessary

## II. LOW GASOLINE ENGINE POWER OUTPUT

TROUBLE	CAUSE		REMEDY
When turning throttle greater, speed increase responds slowly or speed is decreased even engine stops	Ignition	Incorrect ignition time	Readjust ignition advance angle
	Fuel supply system	Air in fuel line of fuel line clogged.	Exhaust air or dredge fuel line
		Main jet is not adjusted Properly.	Readjust
		In carburetor, needle valve hole and main jet clogged	Clean and blow to get through
		Fuel cock is clogged up	Clean, replace Damage part.
		Too much carbon fouling in combusting chamber	Clear away
		Air cleaner is clogged up.	Clean filter element

TROUBLE	CAUSE		REMEDY
Do.	Do.	Intake pipe is leaking	Replace or replace it
	Poor compression	Piston or cylinder or piston ring is worn.	Replace it with a new one
		Air leakage from the surface by which cylinder block contacting with cylinder head.	Replace cylinder gasket
		Too big or too small valve clearance.	Adjust it
		Valve tightness is poor	Repair

### III. GASOLINE ENGINE CANNOT RUN SMOOTHLY

TROUBLE	CAUSE	REMEDY
Engine is pinking	Piston, cylinder or piston ring is worn excessively.	Replace the worn
	Piston pin and piston pin hole are worn excessively.	Replace piston or piston pin
	Tie rod small head is worn excessively.	Replace tie rod
Do.	Roller bearing for crankshaft main shaft is worn	Replace roller bearing
TROUBLE	CAUSE	REMEDY
Abnormal combustion	Engine is too hot	Shoot trouble
	Too much carbon fouling in combustion chamber	Clear away
	Improper gasoline brand or low gasoline quality	Replace with qualified gasoline
Engine cannot start because of spark lacking	There is water in floater room	Clean
	Improper spark plug electrodes Clearance	Adjust
	Incorrect ignition time	Readjust
	Something wrong with induced coil, And so on	Check and replace Damaged parts

#### IV. STOP SUDDENLY WHEN RUNNING

<b>TROUBLE</b>	<b>CAUSE</b>		<b>REMEDY</b>
Stop suddenly	Fuel supply system	Fuel is used up	Fill fuel
When running	Do.	Carburetor is clogged	Check fuel line and dredge
		Floater is leaking	Repair
		Needle valve sticks	Dismantle floater chamber And eliminate it
<b>TROUBLE</b>	<b>CAUSE</b>		<b>REMEDY</b>
When running	Ignition system	Spark plug is struck through, or short-circuited by carbon deposit	Replace spark plug
		Side electrode of spark plug is dropped out	Replace spark plug and remove the dropped object
		Hi-voltage wire is dripped out	Connect it
		Engine oil in the crankcase is insufficient	Add engine oil until it arrives the upper level

Do.	Do.	Ignition coil is struck through to be short-circuited	Replace ignition coil with new one
		Parking wire is located on the engine body	Find out meeting and insulate
	The other	Cylinder is pulled considerably, valve falls off	Repair or replace damaged parts



## V. GASOLINE ENGINE IS EXCESSIVELY HOT

TROUBLE	CAUSE	REMEDY
Gasoline engine is excessively	Improper ignition time	Adjust ignition advance angle properly
	Insufficient engine oil supply	Refill sufficient engine oil
	Exhaust pipe is clogged	Dredge exhaust pipe
Do.	Flow guard is leaking	Repair leakages
	Dirt or something like the fill up among air cooling fins	Clear away dirt or something like this
	Cooling fan is loosen, losing function	Reinstall it well
	Cylinder, piston or piston ring is worn, Resulting in air flow between cylinder and crankcase	Replace tie rod
	Tie rod deformation makes piston and Cylinder bushing side wear.	Replace tie worn part
	Improper adjustment of engine speed produces excessive rotational speed	Readjust engine speed to proper value by speed regulator
	Bearing of crankshaft is burn out	Replace main bearing

**NOTE:** The gasoline engine should run under certain temperature. Generally, permitting temperature at the flow guard outlet is between 80~110°C, while the temperature of the crankcase is about 60°C

under the magneto. If temperatures surpass the limits, it is an indication that gasoline engine is excessive hot.

## VI. THERE IS ABNORMAL NOISE WHEN ENGINE RUNNING

TROUBLE	CAUSE	REMEDY
There is noise of beating or piston slap is heard	Piston or piston ring or cylinder is worn	Replace the worn
	Tie rod or piston pin and piston pin hole is worn	Replace the worn
	Main bearing of crankshaft is worn	Replace
	Piston ring is broken	Replace
There is metal-beaten noise in abnormal combustion	Too much carbon deposit in combusting chamber	Clear away carbon deposit
	Too small electrodes clearance of spark plug	Adjust electrodes clearance properly
	Engine is flooded with fuel	Check relative parts such as carburetor
	Improper fuel brand	Replace fuel
	Engine is excessively hot	Shoot trouble

<b>TROUBLE</b>	<b>CAUSE</b>	<b>REMEDY</b>
The other	Improper valve clearance	Readjust valve clearance properly
	Fly wheel is not connected to crankshaft Tightly	Connect tightly

## SPECIFICATIONS

### I . MAIN SPECIFICATIONS

Model Items	168F-C/168FD-C	168F-2C/168FD-2C	170F-C/170FD-C
L × W × H (mm)	305×365×335mm <305×385×335mm>	313×376×335mm <313×396×335mm>	313×376×335mm <313×396×335mm>
Dry weight (kg)	14Kg<16Kg >	16 Kg<17.9Kg >	16 Kg<17.9Kg >
Engine type	4-stroke, OHV, single cylinder tilt 25°		
Displacement (cm <sup>3</sup> )	163cm <sup>3</sup>	196cm <sup>3</sup>	212cm <sup>3</sup>
Bore × stroke (mm)	68×45mm	68×54mm	70×55mm
Max. Power in theory (kW/r/min)	3.2kW /3600rpm	4.0kW /3600rpm	4.2kW /3600rpm
Power recommended (KW/r/min)	3.0kW /3600rpm	3.8kW /3600rpm	4.0kW /3600rpm
Max. Torque (N· m /r/min)	8.6 N.m/3000rpm	10.5 N.m/3000rpm	11.5 N.m/3000rpm

Fuel consumes. (g/kWh)	$\leq 395$ g/kwh
Cooling system	Force air - cooled
Ignition system	Non – transistorized ignition (TDI)
Spark plug type	F6TC, BPR6ES (NGK)
Out direction of power shaft	Counterclockwise

### Date relating to Adjustment

Item	Date	
Spark plug clearance	0.7~0.8mm	
Carburetor idling	1500±100rpm	
Valve clearance (cold engine)	Intake: 0.15±0.02mm;	Exhaust: 0.20±0.02mm

### NOTES

- Technical data vary with type of engine; therefore, they are subject to change without notice.
- Data in < > are suitable for engine which is equipped with reducer.

### II . TIMING OF DISTRIBUTION

Intake valve opening: BTDC10°;  
 Intake valve closing: ABDC20°;  
 Exhaust valve opening: BBDC30°;  
 Exhaust valve closing: ATDC10°

### III. TIGHTENING TORQUE OF IMPORTANT BOLTS

S/N	Item	Torque Value (N · m)
1	Cylinder head bolt	34
2	Flywheel bolt	118
3	Crankcase cover bolt	24
4	Connecting rod bolt	14

# Electric Diagram (electric start)

## ELECTRIC DIAGRAM (for electric-start type)

Bl	Black	Gr	Grey
Y	Yellow	R	Red
W	White	G	Green

Switch combination			
	IG	E	ST   BAT
OFF	○	○	
ON			
START			○

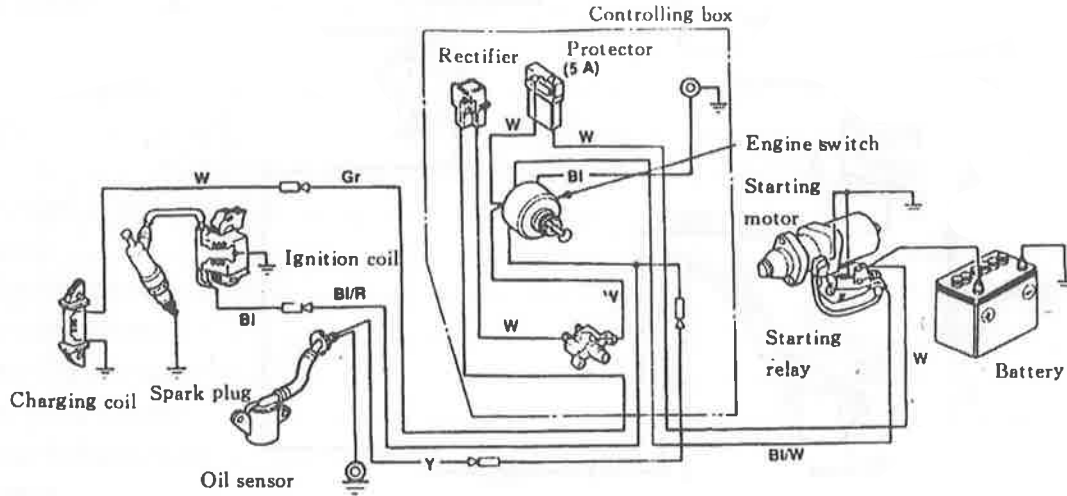

Except Electric Start Model, Different Model have different electric diagram.

## ELECTRIC DIAGRAM

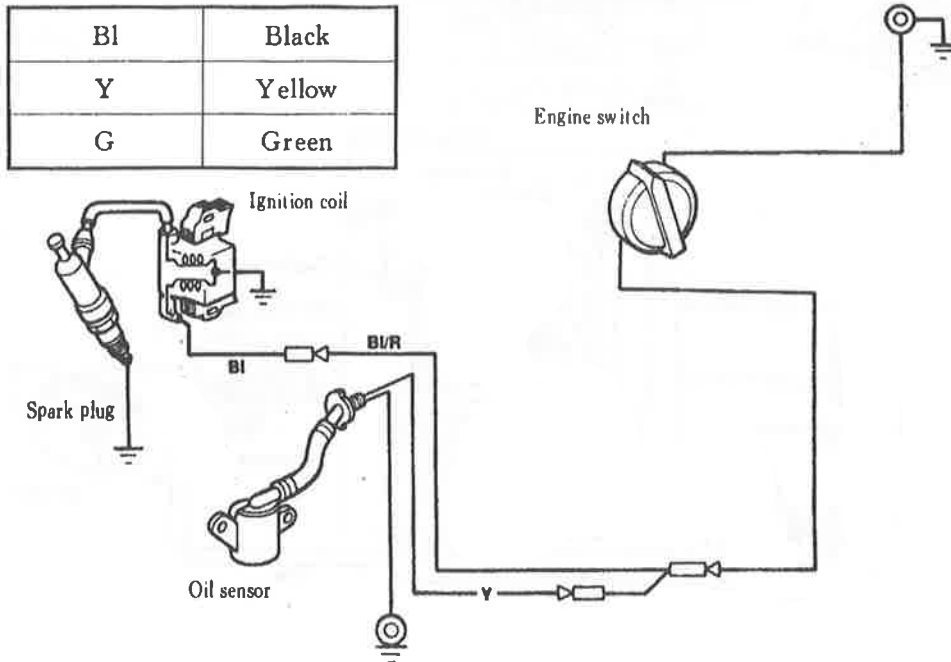

## Guide d'utilisation

# Moteurs à essence LIFAN

M70R (170F-2R)



### **Introduction**

Merci d'avoir choisi ce produit de qualité. **Afin de minimiser le risque de blessures, nous vous prions de toujours prendre les mesures de sécurité adéquates quand vous utilisez cet appareil. Nous vous prions de lire attentivement ce guide.**

L'intérieur du moteur de l'appareil ne comprend aucune partie qui puisse être entretenue par l'utilisateur. Laissez faire l'entretien, l'équilibrage et les réparations éventuelles à du personnel qualifié.

### **Sous réserves de modifications techniques!**

A cause d'un développement continu, les illustrations, fonctions et données techniques peuvent varier légèrement.

### **Actualisation de la documentation**

Si vous avez des propositions à nous faire concernant une amélioration des produits ou si vous avez constaté des irrégularités, ne manquez pas de nous contacter..



### Caractéristiques du moteur à essence Lifan:

- Un cylindre, 4 temps
- Démarreur manuel et/ou électrique
- Système de refroidissement à l'air
- Soupape en tête, OHV
- Système d'allumage magnéto transistorisé
- Couvercle-ventilateur en tôle d'acier.

Notre série de moteurs à essence quatre temps à refroidissement à l'air a été développée en fonction d'une économie d'énergie maximale.

Ce manuel d'utilisation vous aide à utiliser ce moteur de façon optimale. Veuillez le lire attentivement **avant** d'utiliser votre moteur. Sa durée de vie en sera prolongée.

Dans certains cas, l'appareil peut être équipé de façon différente à celle décrite ci-dessous.





## 1. Consignes de sécurité:

Pour votre propre sécurité nous vous prions de suivre les informations et les conseils suivants, sinon vous risquez de mettre l'utilisateur en danger, de lui causer des blessures ou d'endommager votre appareil.

- Veuillez-vous assurer que le moteur est mis en marche dans un endroit bien aéré. Les gaz qui s'en échappent causent des risques pour la santé.
- Assurez-vous que rien n'est placé devant le pot d'échappement, il ne doit être ni couvert ni bouché.
- Avant de faire le plein d'essence, assurez-vous toujours que l'appareil est à l'arrêt.
- Le réservoir ne doit pas être trop rempli.
- Si vous avez fait déborder du carburant en faisant le plein, vous devez absolument l'assécher avec un chiffon avant de mettre le moteur en marche.
- En cas de vidange d'huile, assurez-vous que le bouchon du réservoir à essence est bien fermé pour qu'il n'y ait pas d'huile qui puisse couler dans le réservoir à essence.
- Ne faites pas fonctionner l'appareil près de flammes ou près de substances inflammables.
- Garder le moteur à une distance d'au moins un mètre de tout objet.
- Assurez-vous que toutes les parties mobiles ou en rotation du moteur sont couvertes. Ne pas enlever les protections de l'équipement.
- Pendant son fonctionnement, certaines parties du moteur dégagent de la chaleur. Ne pas vous approcher de ces zones pour éviter les risques de brûlures.
- Mettez le moteur en marche dans un endroit sûr, et gardez les enfants à distance.
- Installer l'appareil sur une surface plane et horizontale afin d'éviter des débordements d'essence et les problèmes de lubrification.
- Attention! Veuillez à ce que l'essence ne déborde pas pendant un transport éventuel. Nous recommandons de vider le réservoir et de fermer le robinet d'arrivée d'essence.



## Tolérances d'inclinaison du moteur Lifan

<b>Inclinaison arbre sortie</b>		
<b>Inclinaison autorisée</b>	< 20°	
<b>Inclinaison du moteur</b>		
<b>Inclinaison autorisée</b>	< 20°	

## 2. Préparation avant la mise en marche :

- 2.1 Assurez-vous que les tuyaux d'arrivée de carburant sont bien raccordés afin qu'il n'y ait pas de fuites.
- 2.2 Assurez-vous que tous les boulons de fixation et que tous les écrous sont bien serrés.
- 2.3 Huile à moteur



### ATTENTION:

*La qualité de l'huile à moteur est un atout primordial pour une bonne performance et une longue durée de vie du moteur. N'utilisez jamais d'huile à moteur usée ou bien de l'huile végétale. Vérifiez le niveau d'huile avant chaque utilisation.*

*Utilisez exclusivement de l'huile minérale pour moteur 4 temps SAE 10W/30 ou SAE 5W/30 lorsque la température est très froide.*

### Capteur de bas niveau d'huile

Le capteur de bas niveau d'huile a pour but d'éviter un endommagement du moteur. Avant que le niveau d'huile à moteur ne tombe en dessous de la limite de sécurité dans le carter de vilebrequin, le moteur va s'éteindre automatiquement (bien que l'interrupteur principal soit sur la position ON). Lorsque le moteur s'éteint et qu'il ne démarre plus, veuillez en premier lieu vérifier le niveau d'huile. Dévissez la jauge d'huile et essuyez. Replacez la jauge dans l'orifice de remplissage sans la visser et retirez-la pour lire le niveau d'huile. Si le niveau d'huile est trop bas, ajoutez l'huile jusqu'à l'extrémité supérieure de l'orifice de remplissage.

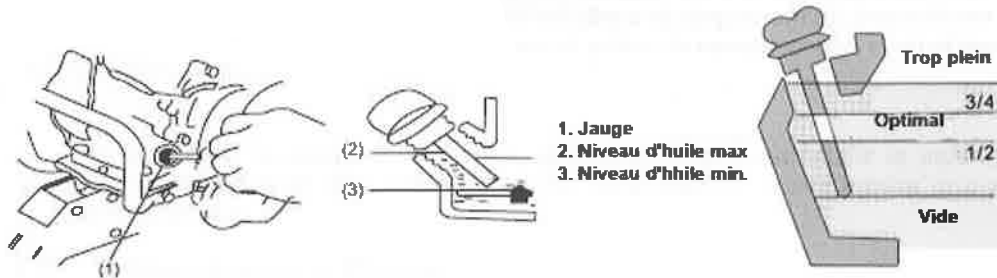

### ATTENTION:

*L'utilisation avec une très faible quantité d'huile peut endommager gravement le moteur.*

## 2.4 Essence

Enlevez le bouchon de remplissage pour vérifier le niveau d'essence. En ajouter au besoin. Utilisez uniquement de l'essence sans plomb. N'utilisez jamais un mélange d'essence et huile. Evitez que de la poussière, de la saleté ou de l'eau ne s'introduisent dans le réservoir.

Capacité du réservoir à essence :

- 170F-C : 3.6L
- 170FD-C : 3.6L
- 190F-TD: 6.5L



**ATTENTION:**

**L'essence est un liquide extrêmement inflammable et peut être explosif.**

**Faites le plein d'essence uniquement lorsque le moteur est éteint dans un endroit bien aéré sans flammes ni étincelles. Ne pas fumer.**

**Après avoir fait le plein, assurez-vous de bien fermer le bouchon du réservoir d'essence. Si de l'essence est renversée, essuyez l'essence renversée avec un chiffon.**

**Ne laissez jamais le moteur tourner dans un endroit fermé. Les gaz d'échappement contiennent du monoxyde de carbone. Ce gaz inodore et incolore peut entraîner la perte de la connaissance et même la mort.**

## 2.5 Filtre à air

Enlevez l'écrou papillon, la rondelle et le couvercle. Vérifier le filtre et nettoyez le au besoin.

 **ATTENTION:**

*Le moteur ne doit pas fonctionner sans filtre à air car des saletés et des particules de poussière vont être aspirées et peuvent causer une usure prématurée.*

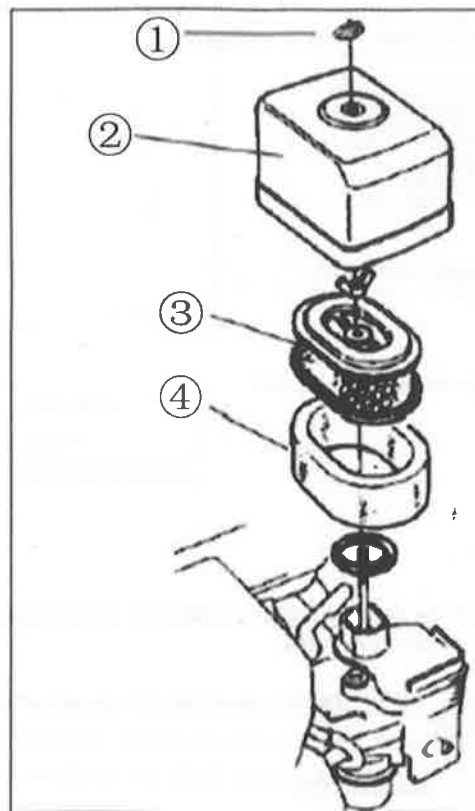

- 1: Écrou papillon
- 2: Couvercle de filtre à air
- 3: Filtre en papier
- 4: Filtre en mousse

## 3. Mise en service

### 3.1 Avant la mise en service

Pour votre propre sécurité et afin de prolonger la durée de vie de votre moteur, il est nécessaire de consacrer quelques instants à la vérification de celui-ci.

Assurez-vous que le moteur est installé sur une surface plane et est bien éteint. Afin d'éviter un danger de feu, gardez le moteur à une distance d'au moins 1 mètre des murs et des objets. Eloignez tous les objets inflammables à proximité du moteur.



#### **ATTENTION:**

***Un mauvais entretien et un mauvais maniement du moteur peut provoquer de graves blessures. Vérifiez le moteur avant chaque utilisation.***

#### 3.1.1 Vérification du moteur

Vérifiez le niveau d'huile avant chaque utilisation.

Vérifiez le filtre à air.

Vérifiez le niveau d'essence et faites le plein au besoin.

### 3.2 Démarrage du moteur

3.2.1 Ouvrir l'arrivée d'essence

3.2.2 Si le moteur est froid, placez le levier de l'étrangleur en position de démarrage.  
Si le moteur est chaud, laissez l'étrangleur en position Arrêt.

3.2.3 Bouger l'accélérateur de la position "OFF" (arrêt), environ 1/3 du chemin vers la direction de la position "ON" (marche).

3.2.4 Mettre l'interrupteur de démarrage en position "ON".

3.2.5 Tirez légèrement sur la poignée du démarreur manuel jusqu'à ce que vous ressentiez une résistance et tirez fortement par la suite. Laissez la poignée se remettre doucement en place pour éviter tout dommage au démarreur.

3.2.6 Si le moteur est froid, replacez lentement l'étrangleur en position d'arrêt.

### 3.3 Réglez la vitesse du moteur

Après le démarrage du moteur, placez la manette d'accélérateur en position "rapide".

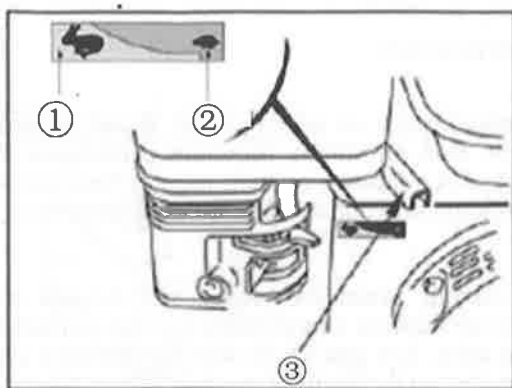

- 1 : Rapide
- 2 : Lent
- 3 : Accélérateur

Le moteur doit fonctionner à la puissance et à la vitesse spécifiée par le fabricant. Si vous remarquez des anomalies, arrêtez immédiatement l'appareil. Le moteur ne doit pas être surmené dans les 1-3 minutes suivant sa mise en marche.



## 4. Arrêt du moteur

Pour arrêter le moteur en cas d'urgence, mettez simplement l'interrupteur du moteur sur "OFF" (arrêt).

En condition normale, l'arrêt du moteur se fait comme suit :

- 4.1 Mettre l'accélérateur sur le réglage le plus bas.
- 4.2 Mettre l'interrupteur du moteur en position arrêt "OFF".
- 4.3 Fermer le robinet d'essence.

## 5. Nettoyage et entretien

Afin de garder le moteur dans un état optimal, il est nécessaire de le nettoyer et de le vérifier régulièrement. Des entretiens réguliers prolongent de manière significative la durée de vie de l'appareil. Le tableau suivant montre les intervalles d'entretien du moteur ainsi que certains points qui doivent être pris en considération.



### ATTENTION:

*Éteindre le moteur avant de passer aux travaux d'entretien! Si vous devez entreprendre ces travaux quand le moteur est en marche, veuillez le faire dans un endroit bien aéré. Les gaz de moteur contiennent du monoxyde de carbone et peuvent entraîner un évanouissement ou même mener à la mort.*

Tableau des travaux d'entretien:

Fréquence		Avant chaque utilisation	Premier mois ou 20 h	Premier 3 mois ou 50h	Premier 6 mois ou 100h	1 An ou 300h
Travaux						
Huile à moteur	Vérification	X				
	Remplacement		X		X	
Filtre à air	Vérification	X				
Bougie				X		X
Protecteur d'étincelles	Vérification		100 h			
Tuyau d'essence			200 h			

## 5.1 Remplacement de l'huile à moteur

**Utilisez seulement de l'huile à moteur minérale SAE 10W/30 pour l'été et SAE 5W/30 pour l'hiver.**

Le changement d'huile doit se faire avec un moteur chaud.

1. Dévissez la jauge d'huile et le bouchon de vidange, laissez l'huile couler dans un récipient collecteur et revissez le bouchon de vidange.
2. Remplir avec de l'huile neuve.
3. Vissez la jauge d'huile.

Quantité d'huile:

170F-C : 0.48L

170FD-C :0.48L

190F-TD: 1.1L

### **Avis**

***Ne pas jeter l'huile usagée mais plutôt la récupérer selon les réglementations nationales.***

## 5.2 Entretien du filtre à air

Un filtre à air sale réduit la quantité d'air dans le carburateur. Afin d'éviter des problèmes au niveau du carburateur, nettoyer régulièrement le filtre à air.



### **ATTENTION:**

***Ne pas nettoyer le filtre à air avec de l'essence ou des solvants. Cela peut provoquer un incendie et/ou une explosion.***



### **ATTENTION:**

***Ne pas faire fonctionner le moteur sans filtre à air, autrement la saleté et la poussière peuvent être aspirées ce qui aura comme conséquence une usure prématurée.***

- 5.2.1 Dévisser le boîtier du filtre à air
- 5.2.2 Laver le filtre à air dans un liquide contenant un détergent de nettoyage, sécher par la suite.
- 5.2.3 Tremper le filtre à air dans de l'huile de moteur propre et essorer l'huile en trop.
- 5.2.4 Remontez le filtre à air.

### 5.3 Entretien de la bougie

Afin de préserver le moteur et le garder dans un bon état, l'écart de l'électrode de bougie doit être réglé correctement et la bougie doit être exempte de tout encroûtement et encrassement.

5.3.1 Vérification du connecteur à bougie

5.3.2 Examen visuel de la bougie. Remplacer la bougie si présence d'une grande usure ou de joints endommagés. Avant de revisser la bougie, assurez-vous de la nettoyer avec une brosse métallique.

5.3.3 Mesurer l'écartement des électrodes des bougies avec une jauge et ajuster en tordant les électrodes latérales. La distance des électrodes doit être comprise entre 0,7 et 0,8 mm.

5.3.4 Remplacer le joint de la bougie s'il devait être endommagé. Visser la bougie en utilisant une clé à bougie.

#### **Avis**

***Lors du vissage d'une bougie neuve: Après que le joint se soit introduit jusqu'à la butée, visser encore un demi-tour environ. Notez qu'une bougie usagée sera vissée après  $\frac{3}{4}$  de tour.***



#### **ATTENTION:**

***Assurez-vous que la bougie soit fermement serrée, autrement elle peut devenir très chaude et endommager le moteur. N'utilisez jamais une bougie d'allumage avec des valeurs thermiques incorrectes!***



#### **ATTENTION:**

***Lorsque le moteur tourne, le pot d'échappement est brûlant. Ne pas toucher pour éviter de se brûler!***

## 6. Usage en haute altitude

La performance du moteur diminue avec l'altitude.

Pour un bon fonctionnement en haute altitude, le moteur nécessitera un nouveau carburateur et un ajustement spécial.

En cas de besoin, demander à votre revendeur.

## 7. Transport et Entreposage



**ATTENTION:**

**Avant de transporter ou entreposer votre moteur, il faut le laisser refroidir pendant au moins 20 minutes. Fermer le robinet d'essence pendant le transport. Et surtout veiller à un transport en position droite pour éviter des fuites d'essence.**

7.1 L'endroit de stockage doit être sec et propre.

7.2 Vider le réservoir à essence.



**ATTENTION:**

**L'essence est une substance inflammable et explosive.**

- Fermer le robinet à essence. Vider la cuve du carburateur, recueillir l'essence.
- Ouvrir le robinet à essence.
- Visser la vis de vidange du carburateur

7.3 Remplacer l'huile à moteur.

7.4 Dévisser la bougie d'allumage et ajouter environ une cuillère à soupe d'huile à moteur dans le trou de la bougie. Tourner à plusieurs reprises le moteur, pour que l'huile se répartisse de manière uniforme, revisser la bougie d'allumage.

7.5 Tirez le démarreur manuel jusqu'à la résistance, ensuite tirer lentement, jusqu'à ce que le marquage triangulaire sur la roue de lanceur s'aligne sur le trou taraudé du démarreur. Dans cette position, les soupapes d'admission et la soupape d'échappement sont fermées. Ceci protège l'intérieur du moteur de la rouille.

7.6 Couvrir le moteur pour le protéger de la poussière.

## 8. DEPANNAGE

### 8.1 Le moteur ne démarre pas

Vérifier ce qui suit:

- Vérifier le niveau d'essence dans le réservoir
- Assurer vous que le robinet d'essence est ouvert
- Vérifier s'il y a de l'essence au carburateur en dévissant la vis de purge au bas du carburateur.
- Assurer vous que l'interrupteur de démarrage est en position ON
- Vérifier le niveau d'huile à moteur
- Vérifier le bon fonctionnement de la bougie
  - Enlever le connecteur, enlever les saletés et dévisser la bougie
  - Replacer la bougie dans son connecteur
  - Placer l'interrupteur d'allumage en position ON
  - Mettre l'électrode sur une pièce métallique du moteur et tirer la poignée du démarreur manuel. Une étincelle devrait apparaitre

Démarrer le moteur

Si le moteur ne démarre toujours pas, veuillez consulter un professionnel.

## 9. Données techniques

Modèle	170F-C 170FD-C	190F-TD			
Cylindrée (CC)	212	420			
Alésage et course (mm)	70 x 55	90 x 66			
Ratio de compression	8.5: 1	8.5: 1			
Demarreur	Manuel ou Manuel/Electrique	Electrique			
Lubrification	Semi sec / Bain d'huile	Semi sec / Bain d'huile			
Poids (Kg)	16/17.9	33			
R.P.M.	3600	3600			
Mandrin	1"	1			

